



# str/nds

## S 40 M

	Ø 40 mm		<b>50Hz</b> 90-135 200-300 440-670 980-1500	<b>60Hz</b> 108-162 240-360 528-805 1175-1800
	190 mm		2,20 kW	2,60 kW
	M24 / M28		<b>mm/r</b> 0,10 0,16 0,24 0,33	<b>inch/r</b> 0,004 0,0064 0,010 0,013
	MK 4			
	500 x 400 mm			



320

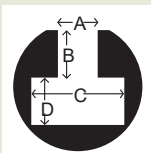

A 14,5 +/- 0,8 mm  
B 13 mm  
C 26 mm  
D 12 mm

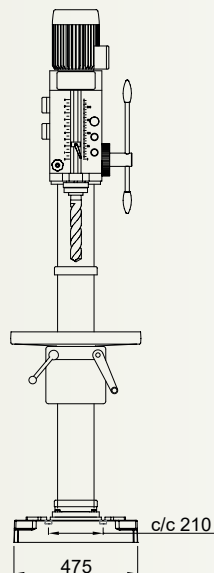
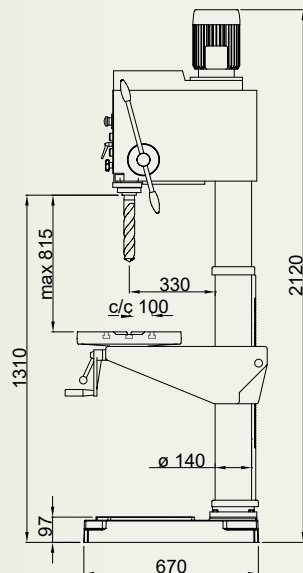

Rätt till ändringar av tekniska data utan förgående meddelande förbehålles.  
We reserve the right to make modifications without prior warning.  
Das recht auf Änderung der vorstehenden Daten behalten wir uns vor.

# Tillbehör S 40 M

Spare parts/Zubehör

strands



T25095



T35000



T25003

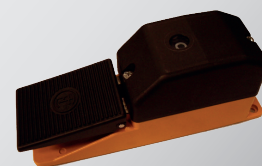

T40010



T40013



T40014

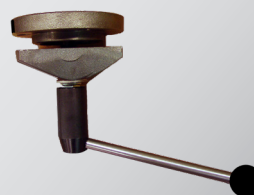

T40021



T40022

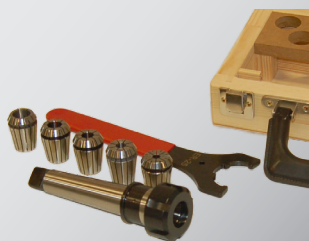

T40042



T40040 0-13 mm

T40041 3-16 mm

Std EU

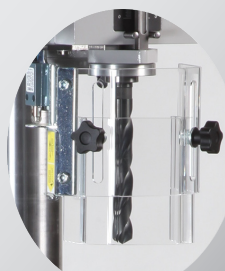

T40051 + T25052

**MSC**  
machinery scandinavia  
MADE IN SWEDEN

  
**ROSENFORS**  
MADE IN SWEDEN

Machinery Scandinavia AB  
577 97 Rosenfors, Sweden  
Tel +46 495 49700  
E-mail: sales@mscab.se  
[www.strandsmachinery.com](http://www.strandsmachinery.com)