

EMCO



High-performance turning/milling center for complete machining



HYPERTURN 65 PM G2

HIGH-PERFORMANCE TURNING/ MILLING CENTER

More clearance, more power, more possibilities: with a spindle distance of 1500 mm, a powerful counter spindle which also allows 4-axis machining, a B-axis with a direct drive for complex 5-axis simultaneous milling operations and all proven, high-quality features of the Hyperturn series, the Hyperturn 65 Powermill-G2 is a powerful addition to every machine range.



Sprocket-wheel (Steel Ck 45)

1 MAIN SPINDLE

- / Integrated spindle motor (ISM) in synchronous technology – water-cooled
- / High drive power 29 (38) kW
- / High torque 250 (800) Nm
- / Large speed range 0 – 5000 (4000) rpm
- / Highly dynamic
- / Bar capacity diameter 65 (102) mm

2 MILLING SPINDLE

- / Powerful milling spindle 37 (30) kW
- / Large speed range 0 – 12000 (20000) rpm
- / Water-cooled motor spindle with HSK-T63 or PSC63
- / Internal and external coolant supply
- / B-axis with zero backlash direct drive
- / B-axis position can be fixed in any position

3 TOOL MAGAZINE

- / 40/80/120-slot chain-type tool magazine
- / Ergonomically arranged up front
- / Easy to be manually loaded with tooling (in parallel with the machining process)
- / Max. tool length 350 mm
- / Max. tool diameter 80 (120) mm
- / Max. tool weight 12 kg

4 COUNTER SPINDLE

- / Integrated spindle motor (ISM) in synchronous technology – water-cooled
- / High drive power 29 (33) kW
- / High torque 250 (420) Nm
- / Wide speed range 0 – 5000 (4000) rpm
- / Coolant feed internal for flushing
- / Hollow clamping system for workpieces with dimensions of $\varnothing 66 \times 550$ ($\varnothing 102 \times 650$) mm

5 UPPER Y-AXIS

- / Large working stroke + / – 120 mm
- / Short cantilever length
- / Pre-loaded roller guides
- / Large guide clearance

6 CONTROL

- / Ergonomically arranged
- / Can be rotated by 90°
- / Height adjustment: +/- 100 mm
- / Sinumerik ONE
- / 22" multi-touch display including IPC and EMCONNECT process assistant

7 CHIP CONVEYOR

- / Hinged type conveyor belt
- / Throw-off height 1200 mm

8 COOLANT SYSTEM

- / 980 l band filter system
- / 980 + 200 l coolant volume
- / 25 bar milling spindle process pump
- / 25 bar turret process pump
- / 2x 4.3 bar purge pumps

9 SMALL GANTRY

- / Integrated workpiece unloading device
- / Servo-controlled horizontal/vertical movements
- / Waste piece removal from the main spindle
- / Max. workpiece size: $\varnothing 100 \times 400$ mm
- / Max. workpiece weight: 10 kg

10 ACCUMULATION CONVEYOR FOR FINISHED PARTS + STORAGE AREA

- / Storage area: approx. 420 x 1350 mm
- / Max. weight load: 130 kg



DESIGN

1 MACHINE BED

- / Single-piece machine design
- / Torsion-resistant welded steel construction
- / Filled with HYDROPOL® special concrete

2 ROLLER GUIDES

- / In all linear axes
- / Large distance between the guides

3 MAIN SPINDLE

- / Large speed range
- / C-axis for milling operations
- / Additional holding brake
- / KK 8 spindle connection
- / Hollow clamping system with stroke monitoring

4 COUNTER SPINDLE

- / Large speed range
- / C-axis for milling operations
- / Additional holding brake
- / KK 8 spindle connection
- / Full clamping system with stroke monitoring
- / Hollow clamping system with built-in flush nozzles

5 MILLING SPINDLE

- / HSK-T63 or PSC63 (CAPTO C6) tool interface
- / Max. tool length: 350 mm
- / Max. tool diameter: 80 (120) mm
- / Max. tool weight: 12 kg
- / Max. coolant pressure: 80 bar

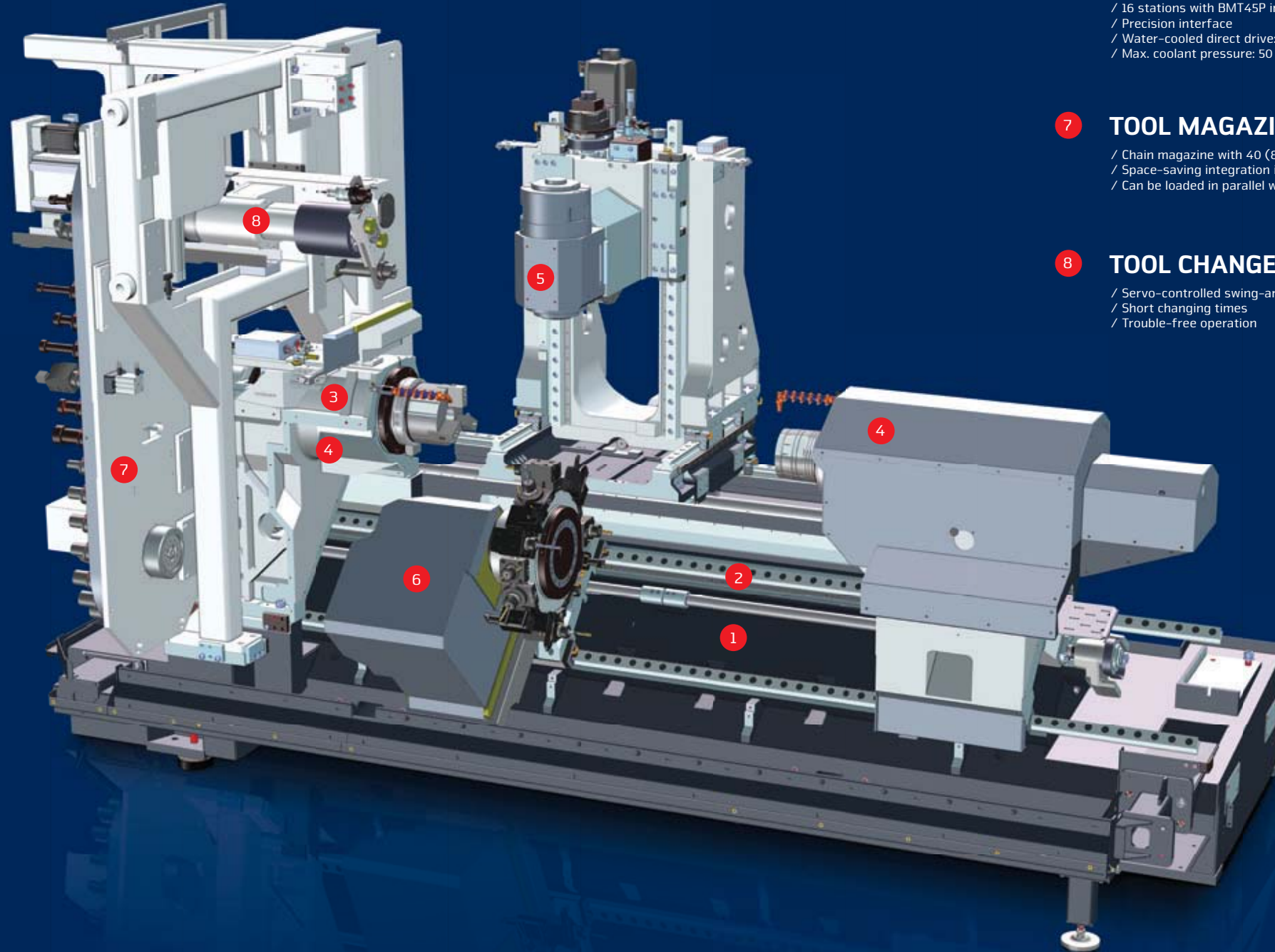

6 TOOL TURRET

- / 12 stations with BMT55P interface
- / 16 stations with BMT45P interface
- / Precision interface
- / Water-cooled direct drive: 12000 rpm
- / Max. coolant pressure: 50 (100) bar

7 TOOL MAGAZINE

- / Chain magazine with 40 (80/120) tool holders
- / Space-saving integration into the basic machine
- / Can be loaded in parallel with the machining process

8 TOOL CHANGER

- / Servo-controlled swing-arm-type tool changer
- / Short changing times
- / Trouble-free operation

Power and Torque

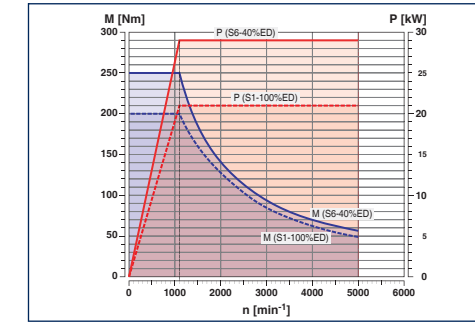

Main and counter spindle \varnothing 65 mm

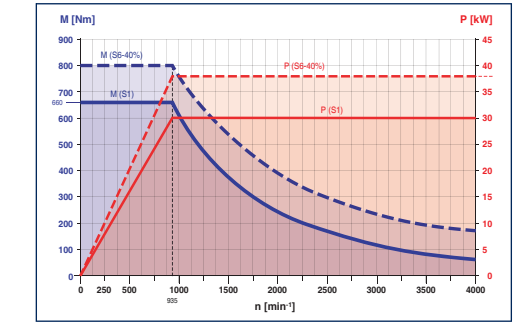

Main spindle \varnothing 102 mm (optional)

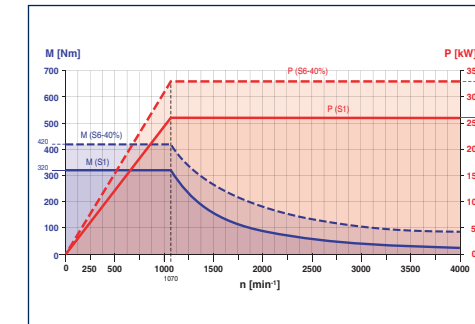

Counter spindle \varnothing 102 mm (optional)

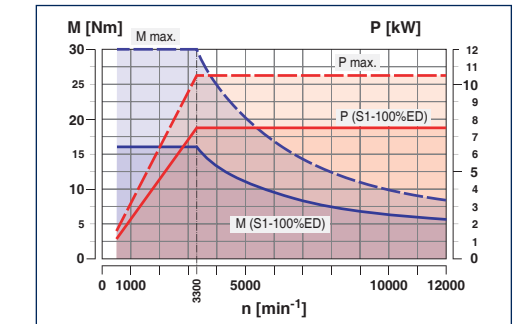

Tool turret BMT55P with direct drive

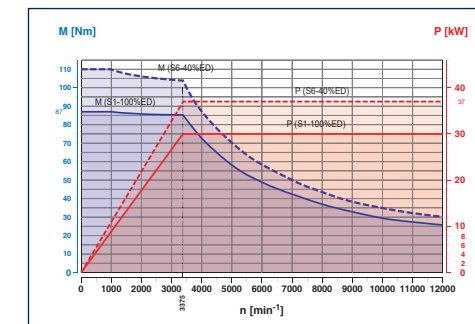

Milling spindle with max. 12000 rpm

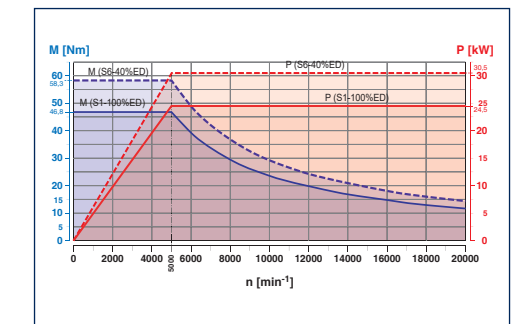

Milling spindle with max. 20000 rpm

TECHNICAL HIGHLIGHTS

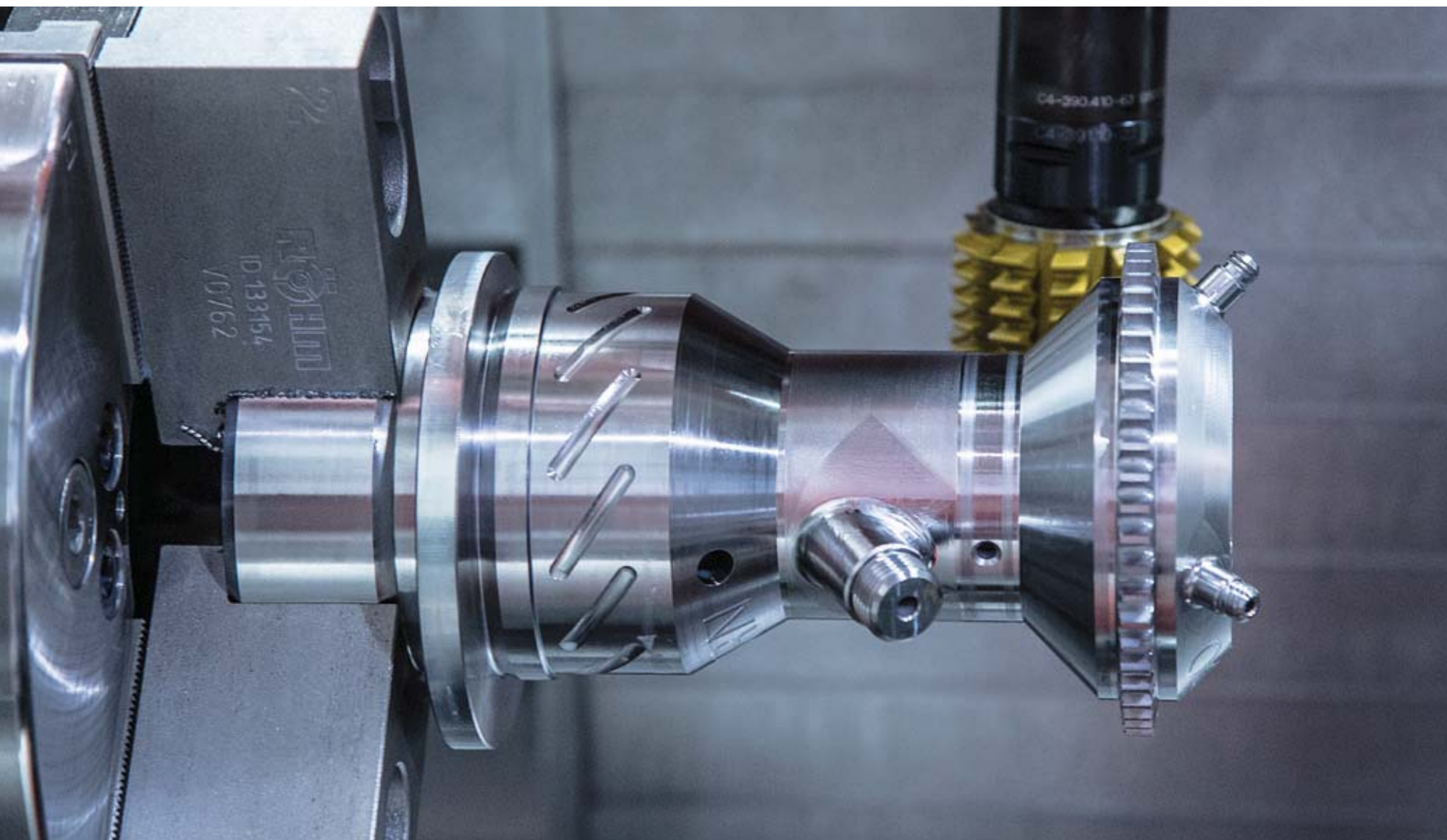

MAIN SPINDLE

With an output of 29 kW and 250 Nm torque, the main spindle is powerful enough to machine from bar-stock up to a diameter of 65 mm and chuck parts up to a diameter of \varnothing 250 mm economically. A larger headstock with a bar capacity of 102 mm and a A2-8 spindle connection is available as an option. The machining process can be performed with 38 kW and 800 Nm.



MILLING SPINDLE

At 37 kW and 110 Nm and a max. speed of 12000 rpm, the HYPERTURN 65 Powermill G2 supports state-of-the-art milling processes such as HSC or HPC. This means that complex turned and milled parts can be produced in an extremely efficient manner. If required, a 20,000-rpm spindle is available as an option.

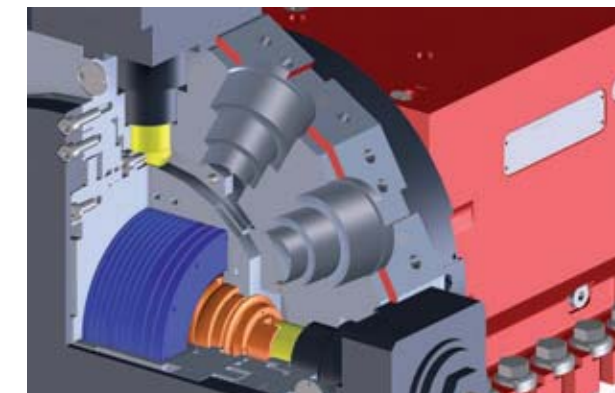

BMT TURRET

Available as an option for simultaneous machining on the main and counter spindle, the BMT turret with water-cooled direct drive comes with a maximum of 12000 rpm, 30 Nm and 10 kW. It is the ideal basis for economic series productions.



COUNTER SPINDLE

The movable counter spindle comes with the same performance data as the main spindle. Depending on the requirements, it is also possible to attach a 102-mm spindle with KK8 spindle connection. The counter spindle's hollow clamping feature makes it possible to fix longer components and allows for increased flexibility. Internal and external flush nozzles ensure clean clamping areas.



TOOL MAGAZINE

Depending on the configuration, the chain magazine can include 40, 80 or 120 tool holders with HSK-A63/HSK-T63 (PSC63) shaft. A swivel-arm changer places the tools into quivers, which protects them against soiling. The magazine, which has been integrated into the machine housing to save space, can be accessed from the front.



CONTROL UNIT

The Sinumerik ONE control is located on the right side of the HYPERTURN 65 Powermill G2's work area on a swivelling, height-adjustable and laterally movable panel. This guarantees perfectly ergonomic working conditions during the machine's set-up and run-in processes.

TECHNICAL HIGHLIGHTS



HOLDING BRAKE ON THE MAIN AND COUNTER SPINDLE

It is always the respective C-axis which is positioned for milling and drilling operations. Additionally, however, it is possible to clamp each spindle in any position.



CLAMPING STROKE CONTROL ON THE MAIN AND COUNTER SPINDLE

Thanks to the programmable clamping stroke control, the clamping positions of the two clamping cylinders can be easily taught in. As a consequence, handling works on the cylinders are no longer required. This leads in turn to shorter set-up times.



MANUAL TOOL CHANGING

The tools can be loaded into the magazine from the front in parallel with the machining process. Thus, the operator is no longer required to walk to the back of the machine. What is more, the tools can be checked for wear and/or breakage in no time.



WORKROOM COVERS

Telescopic panels with force-guided shear kinematics guarantee jerk-free feed movements, even at high traverse speeds. The results: perfect workpiece surfaces and covers with an increased service life.



WORKROOM RINSING SYSTEM

Flexible coolant hoses on the main and counter spindle as well as additional rinsing nozzles in the workroom ensure an optimal chip flow.



MAINTENANCE CENTRE

The maintenance centre is located on the rear left-hand side of the machine. This is where the pneumatic unit and the hydraulic indicators are to be found. It is now possible to programme and determine the clamping pressures in the parts programme. The container for the central lubrication system has been incorporated into the lower area.

HIGHLIGHTS

- / High dynamics due to state-of-the-art spindle motor technology
- / All spindles liquid-cooled for optimum thermostability
- / High productivity due to short tool change times
- / Both tool systems can be used on both spindles
- / Bed design for maximum stability and oscillation damping
- / Excellent repeatability due to linear guides
- / Short set-up times due to ease of access to work area



MAGAZINE - COVER HOOD

If necessary, the cover of the tool magazine can be easily unlocked and opened. Thus, it is possible to check the tool changer and the magazine in case of need.

NETWORKS ARE CREATED INDIVIDUALLY – OUR SOLUTIONS AS WELL



Staying in touch is important not only among human beings. Persons, machines and the whole production environment must also be connected perfectly and safely in order to ensure efficient procedures during the production process. With EMCONNECT, the machine is optimally equipped for this purpose. The optional EMCONNECT Digital Services offer innovative online services for optimized machine operation. The user has always the control of the machine status. The automatic notification in case of malfunctions or standstill of the machine as well as the extended capabilities for remote maintenance, minimise downtimes.



Integration into control

EMCONNECT offers several possibilities of operation according to different situations. For quick access, apps may be used simultaneously in the side panel of controlling.

In this way, you can always look at your familiar numerical control, the well-known centrepiece of the machine.

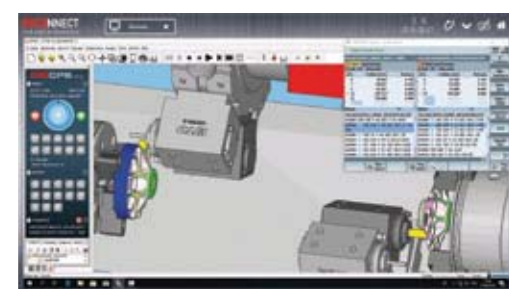

An innovative concept

These powerful apps may be used independently from the control, while in the background the machine is busy in the production process. With only one click, you can change at any moment between numerical control and EMCONNECT. This is possible with the help of an innovative and ergonomic control panel, equipped with a modern 22" multi-touch display, an industrial PC with associated keyboard and HMI hotkeys.

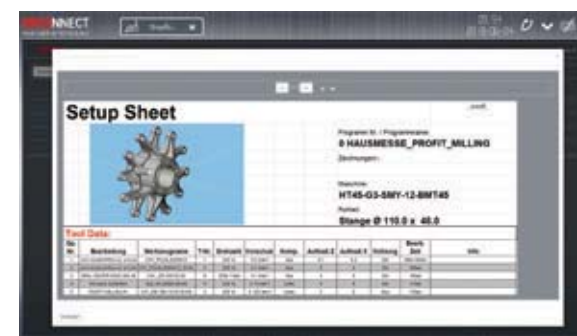

The control panel as central platform

With EMCONNECT, the control panel of the machine becomes the central platform for the access to all the operative functions. The user gets every type of support from the apps, which directly provide all the necessary applications, data and documents. In this way, EMCONNECT makes an important contribution to a highly efficient processing at the machine.



Comprehensive connectivity options

With the remote support, the web browser and the remote desktop, there are numerous connectivity options, even beyond the direct production environment. With the help of the integrated remote support, it is easily possible to carry out the remote diagnosis and remote maintenance. The optionally available OPC UA interface enables data exchange with the IT system environment and interaction with other machines for automation at shop floor level.

EMCONNECT HIGHLIGHTS AND FUNCTIONS

- / Fully connected**
Connection to all applications via remote control of the office computer and the web browser
- / Structured**
Clear monitoring of the machine state and the production data
- / Customized**
Open platform for modular integration of customer-specific applications
- / Compatible**
Interface for seamless integration into the operating environment
- / User-friendly**
Intuitive and production-optimized touch operation data
- / Future-proof**
Continuous extensions as well as easy updates and upgrades

Standard-Apps

Control	Dashboard
Machine Data	System
Remote Desktop	Web Browser
Remote Support	Settings
Cutting Calculator	Calculator
Notes	Service
Documents	EMCO TechSheet
GD&T	File Import
Shopfloor Data	Thread Reference
	Tricalc

Optional

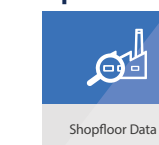

Shopfloor Data

OPTIONS



WORKPIECE PICK-UP DEVICE / SMALL GANTRY

Equipped with two NC axes and available as an option, the small gantry makes it possible to remove the finished parts from the counter spindle and the remaining bar material from the main spindle. The finished parts are carefully placed onto an accumulation conveyor. Max. part size: $\varnothing 100 \times 400$ mm; max. part weight: 10 kg



FINISHED PART CONVEYOR

The Miniportal is used to place the finished parts onto a conveyor belt with a usable storage surface of approx. 420 x 1350 mm. Since the belt is clocked, the sometimes highly complex parts are kept from falling onto each other.

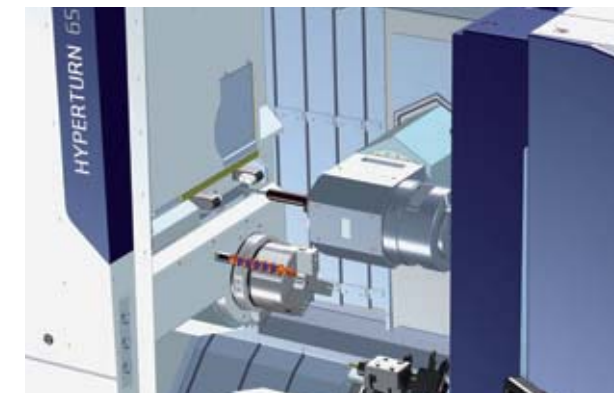

TOOL MEASUREMENT

The laser measuring system located above the main spindle performs contactless and process-reliable measuring and monitoring processes for the rotating tools in the milling spindle. Stationary tools (turning tools) are measured by a probe.



CNC STEADY REST

Several steady rests are available for shaft machining. Small shaft parts can be supported with a turret-mounted steady rest. A CNC steady rest featuring a centring range from 25 to 280 mm is available for large shaft parts.



OIL MIST SEPARATOR

The mechanical oil mist separator cleans the aerosols which are generated in the workroom during the machining process. High separation efficiency and an air flow of 1000 qm/h improve the indoor air quality.



BAND FILTER SYSTEM WITH HIGH-PRESSURE COOLANT PUMPS

A coolant pressure of 25/40/60/80 bar can be set as necessary. This enables coolant-fed drilling and milling tools to be used to their best advantage.



TOOL MEASUREMENT

Tools in the milling spindle and on the turret can be measured quickly and precisely thanks to a tool measuring probe inside the work area. It is mounted into the holder below the main spindle by hand and, after use, put back into its designated storage area.



CLEANING NOZZLE

For cleaning the clamping devices, the covers and the entire work area. This option includes a cleaning nozzle with flow and jet adjustment as well as a solenoid valve, a key switch and a spiral hose.



AUTOMATIC DOOR

Offering maximum comfort for manual workpiece loading, the fully automatic machine door is also the prerequisite for automatic, robot-assisted loading.

INSTALLATION PLAN

Installation plan HT65 PM G2 with band filter system and short bar loader

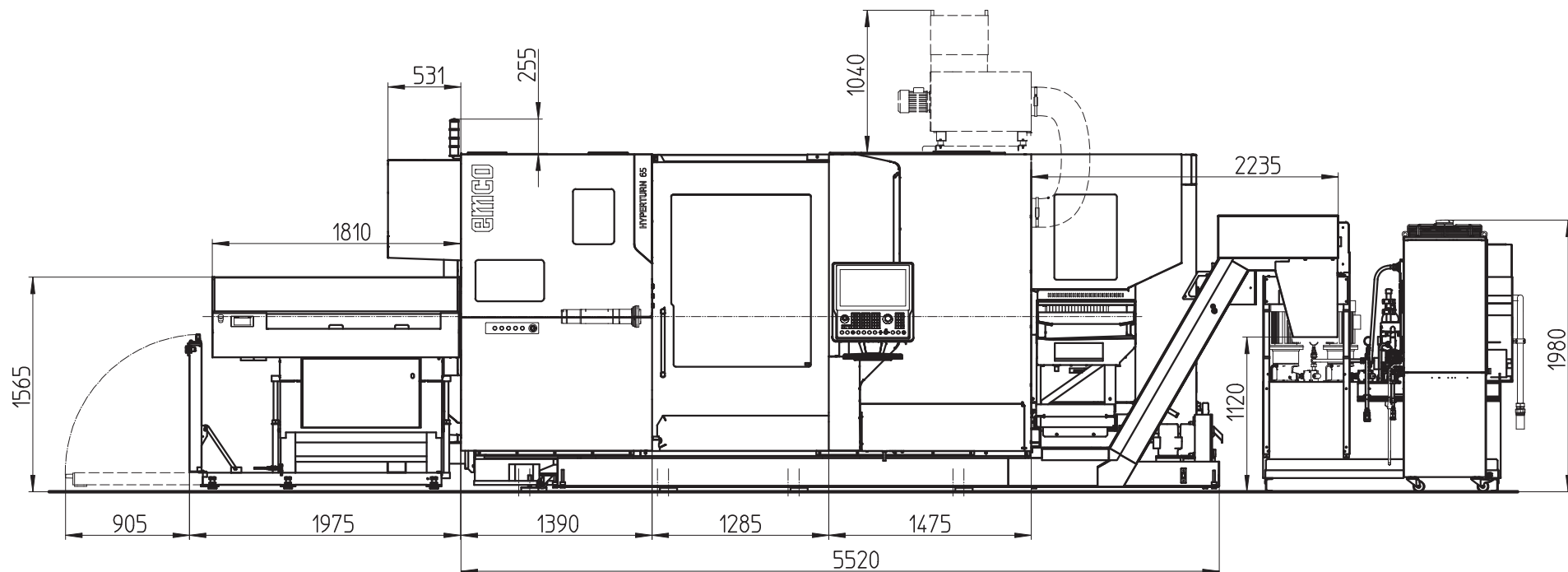

Indications in millimetres

1...Option

INSTALLATION PLAN

Installation plan HT65 PM G2 with band filter system and short bar loader

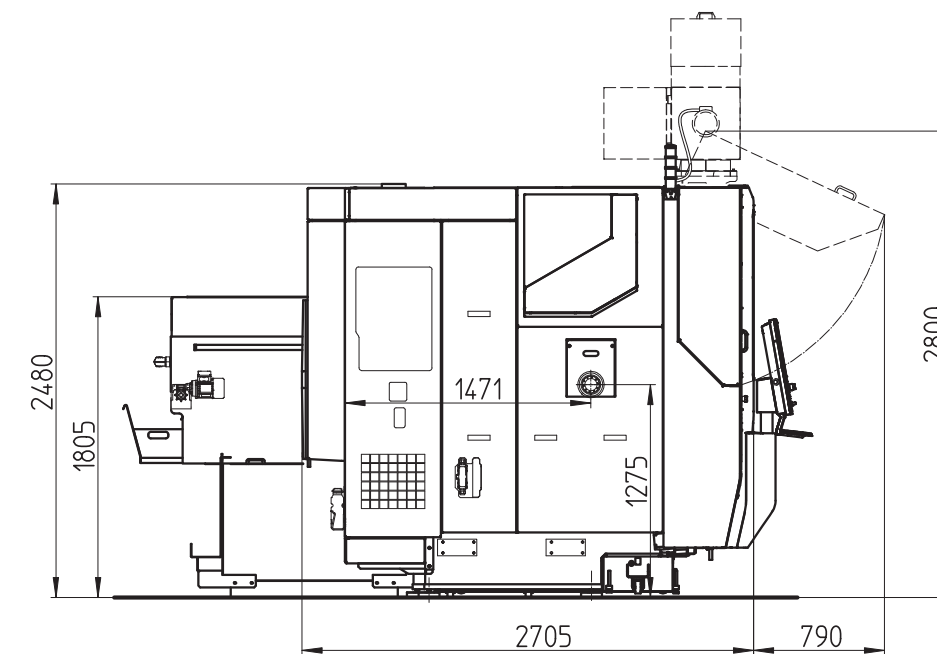

Indications in millimetres

TECHNICAL DATA

Work area

Swing over bed	500 mm
Distance between spindle noses	1500 mm
Maximum turning diameter	500 mm
Max. part length	1200 mm
Max. bar-stock diameter	65 (102) mm

Travel

Verfahrweg X1 / X2	530 / 210 mm
Traverse path Z1 / Z2	1215 / 1205 mm
Traverse path Y	+/- 120 mm
Traverse path counter spindle Z3	1250 mm

Main spindle

Speed range (infinitely variable)	0 – 5000 (4000) rpm
Maximum torque	250 (800) Nm
Spindle nose DIN 55026	KK6 (KK8)
Spindle bearing (inside diameter)	105 (160) mm
Spindle bore (excluding draw-back rod)	Ø 73 (116) mm

Counter spindle

Speed range (infinitely variable)	0 – 5000 (4000) rpm
Maximum torque	250 (420) Nm
Spindle nose DIN 55026	KK6 (KK8)
Spindle bearing (inside diameter)	Ø 105 (160) mm

C-axes

Resolution	0,001°
Rapid traverse	1000 rpm

Drive power

Main spindle (AC integrated-spindle motor)	29 (38) kW
Counter spindle (AC integrated-spindle motor)	29 (33) kW

Milling spindle – Powermill

Speed range	0 – 12000 (20000) rpm
Maximum torque	110 (58) Nm
Maximum drive power	37 (30) kW
Type of tool shank	HSK-T63 or r PCS63 (CAPTO C6)
Resolution of the rotary axis	0,001°
Clamping for turning operations	in any position
Clamping moment	400 Nm
Max. coolant pressure (IKZ)	80 bar
Max. coolant pressure (EKZ)	20 bar

B-axis

Travel range	240°
Resolution of the rotary axis	0,0001°
Rapid traverse speed	360°/sec.
Holding torque of clamp	2000 Nm
Interpolating drive torque	614 Nm

Tool magazine

Tool storage capacity	40 / 80 / 120
Max. tool diameter	Ø 80 (Ø 120) mm
Max. tool length	350 mm
Max. tool weight	12 kg

Tool turret with direct drive

Number of tool positions	12 (16)
Precision interface	BMT55P (BMT45P) / VDI40
Tool cross-section for square-shank tools	25 x 25 (20 x 20)
Shank diameter for boring bars	40 (32)
Tool indexing time	0,5 sec.
Speed range of driven tools	0 – 12000 rpm
Torque of driven tools	30 (20) Nm
Drive power of driven tools	10 (8) kW

Tailstock

Max. Pressing force	14000 N
Travel	1200 mm
Centre punch holder	MK5
Pinole diameter	120 mm

Steady rest SMW SR-3.1

Centring range	Ø 25-165 mm
Lever/ roller width	45/25 mm
Max. Clamping force/ roller	1000 daN
Max. Operating pressure	80 bar

Steady rest SMW SR-4

Centring range	Ø 30-245 mm
Lever/ roller width	60/25 mm
Max. Clamping force/ roller	1500 daN
Max. Operating pressure	70 bar

Feed drives

Rapid speed X1 / X2	30 m/min
Rapid speed Z1 / Z2 / Z3	30 m/min
Rapid speed Y1 / Y2	12 m/min
Feed force X1 / X2	5000 N
Feed force Z1 / Z2	8000 N
Feed force Y	7000 N

Coolant system

Tank capacity	980 + 200 l
Coolant pumps for the tool systems	1x/2x 25 bar
Scavenge pumps for the work area	3x 4,3 bar

Power consumption

Connected load	65 kVA
Compressed air	6 bar

Dimensions / Weight

Height of center above floor	1275 mm
Overall height	2480 mm
Required space L x D (without chip conveyor)	5970 x 2430 mm
Total weight	15000 – 16500 kg

Safety devices CE compliant

beyond standard /

EMCO GmbH / Salzburger Str. 80 / 5400 Hallein-Taxach / Austria / T +43 6245 891-0 / F +43 6245 86965 / info@emco.at

www.emco-world.com